

Mikron

MILL P

900

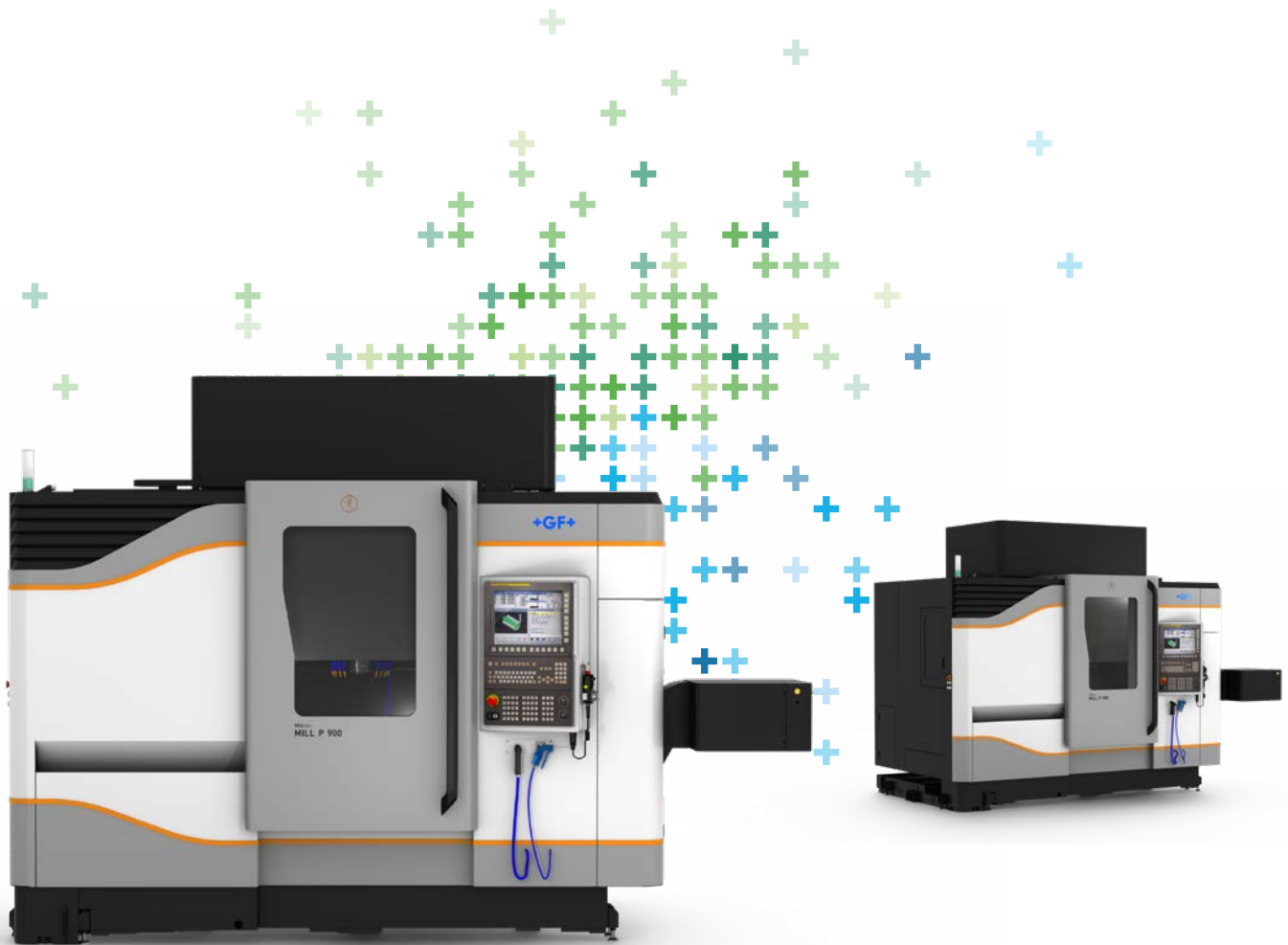

Becoming better every day – since 1802

GF Machining Solutions

When all you need is everything, it's good to know that there is one company that you can count on to deliver complete solutions and services. From unmatched Electrical Discharge Machining (EDM), Laser texturing, Laser micromachining, Additive Manufacturing and first-class Milling and Spindles to Tooling and Automation, all of our solutions are backed by unrivaled customer service and expert GF Machining Solutions training. Our AgieCharmilles, Microlution, Mikron Mill, Liechti, Step-Tec and System 3R technologies help you raise your game—and our digital business solutions for intelligent manufacturing, offering embedded expertise and optimized production processes across all industries, increase your competitive edge.



+ We are Mikron Mill.
We are GF Machining Solutions.

Contents

4	Market segments and applications
6	Technology and Solutions
8	Robust and precise
10	smart machine
11	High-tech motor Spindles
14	Tool magazines
15	Chip management
16	Automation with pallet magazine
18	Our Service + Success range
20	Options
21	Customer Services
22	Technical data
24	GF Machining Solutions

The vertical, three-axis Mikron MILL P 900 is designed in a robust, portal structure with high static stiffness. It guarantees high quality parts for mold-makers in information and communications technology (ICT), automotive, home appliances and consumer goods, with the benefit of real roughing and finishing performance on the same machine.

Market segments and applications

Typical 3-Axis applications

Electronic components



Information and communications technology (ICT)

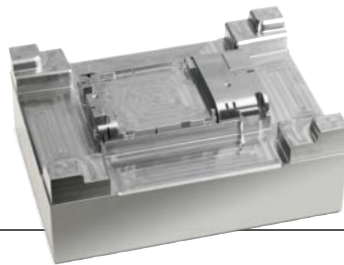

Packaging



Automotive

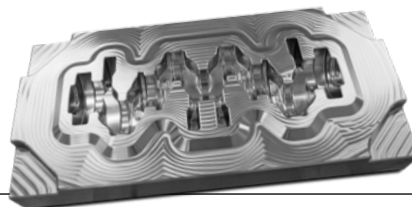

Home appliances

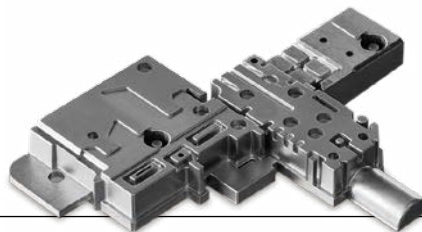

General machinery

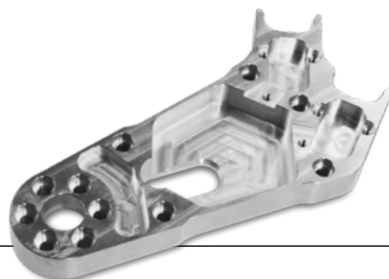

Dynamic and stable

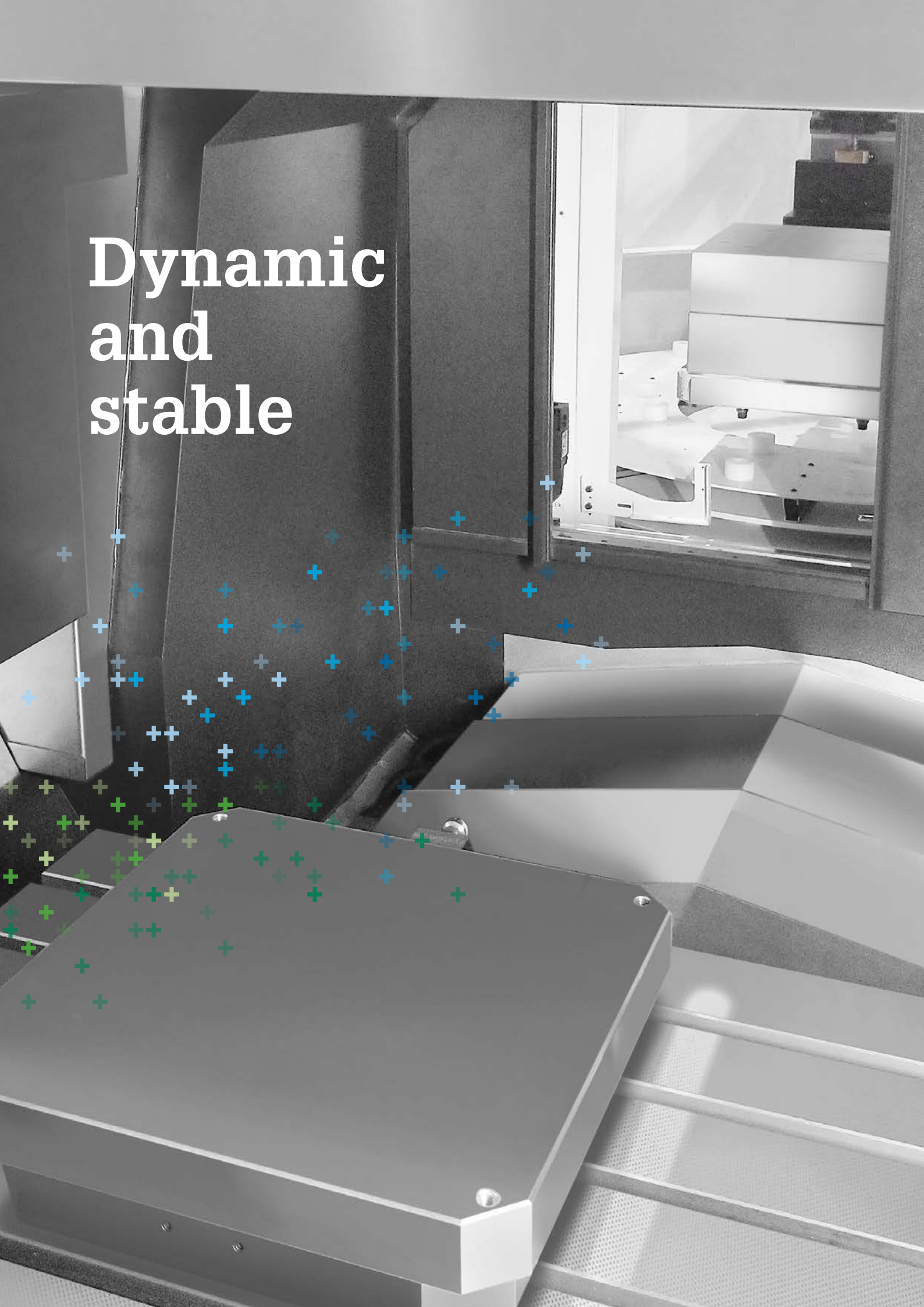

High-performance Milling triggers your success

- + Best surface finish
- + Accuracy
- + High chip removal
- + Outstanding efficiency

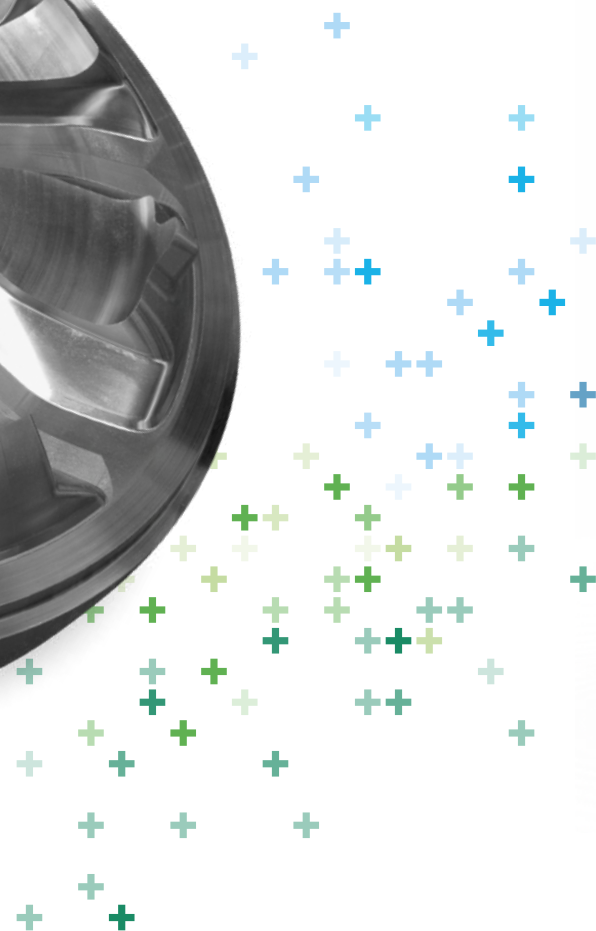

Solutions

The right solution— for you

Performant, stable and precise process thanks to a symmetrical portal architecture allowing roughing and finishing in one machine setup.

Integrated Automation and chip management to accelerate your productivity and efficiency.

Best surface quality and high positioning and contour accuracy, thanks to this high-performance machine's polymer concrete base, thermal management and direct measuring on all axes.

- + Polymer concrete machine base for best damping characteristics
- + Thermostabilized machine body
- + Renowned and stable Heidenhain and Fanuc control
- + High-performance Spindle
- + Ergonomic accessibility
- + Easy to automate



Robust and precise

MILL P 900 core components

+ Robust construction

With its robust portal structure featuring high dynamic stiffness, this solution is especially designed for mold and die and part producers looking for best surface quality and very high positioning and contour accuracy.

+ Power at your fingertip

Experience the power of real roughing and finishing performance on a single machine. This machine range's one-touch process puts them both at your fingertip.

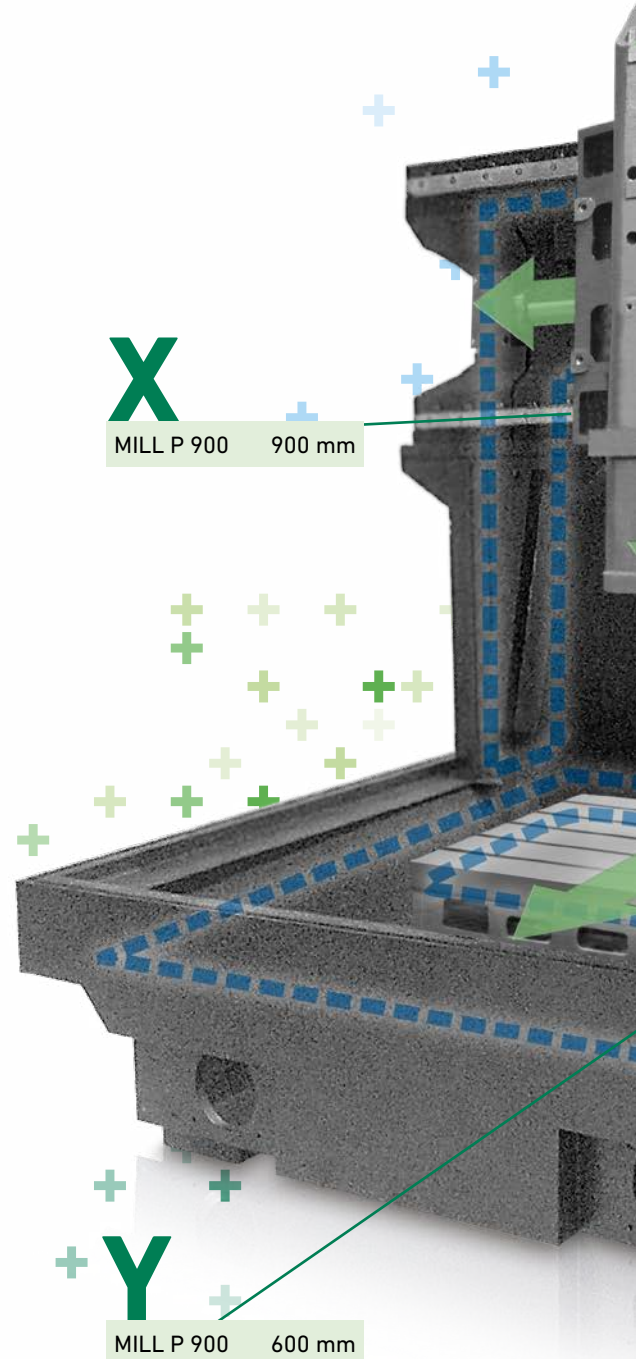

X

MILL P 900 900 mm

Y

MILL P 900 600 mm

Z

MILL P 900 450 mm

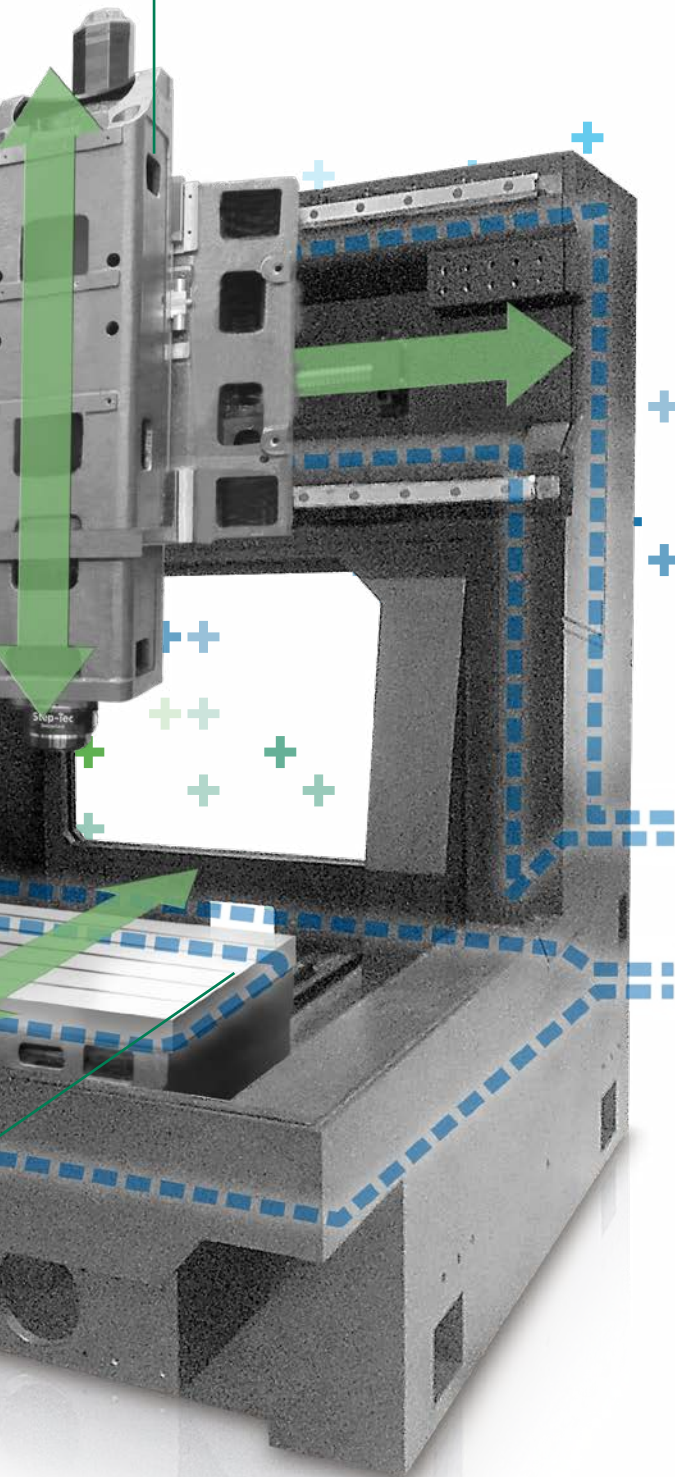

+ Stable accuracy

Experience the high precision that comes from long-term stability and robustness—even in hard Milling. This machine's symmetrical portal design, polymer concrete structure and high thermostability are your foundation for precision.

- Thermostabilized body
- Cooling system for Spindle
- Thermal-controlled drive motors
- Temperature-controlled coolant
- Cooling loop inside table

Fifty-year legacy
of machine design
expertise

smart machine

The new dimension in modern production

This includes a range of modules that are collectively referred to under the generic term “smart machine” and that fulfill various functions. In order to make the Milling process “intelligent,” various requirements have to be implemented.

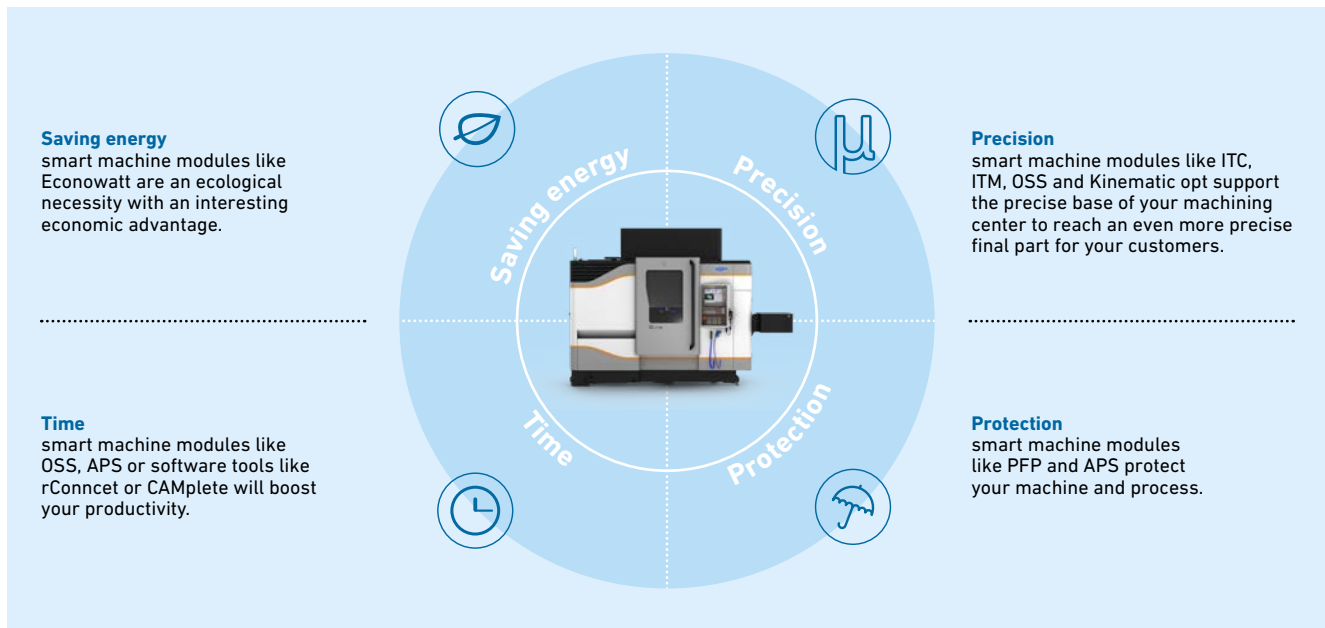

- 1 Establishing comprehensive communication between man and machine, which makes available precise information that the operator requires to assess the Milling process.
- 2 Supporting the operator in the optimization of the process, which considerably improves the performance.
- 3 The machine optimizing the Milling process, which improves process safety and workpiece quality – especially important in unmanned operation.

The facts

- + Greater accuracy in shorter machining times
- + Increase in the workpiece surface quality as well as the surface and shape accuracy
- + Recognition of critical machining strategies
- + Improved process safety
- + Higher availability
- + Better operating comfort
- + Considerable increase in reliability in unmanned operation

smart machine construction kit system

Each of the modules fulfills a specific task. Just like in a construction kit, the user can select the modules that seem to him to be the best option for improving his process.

- Produce your workpieces in a process-secure and precise manner
- Increase reliability in unmanned operation
- Boost the service life of the machine
- Significantly reduce production costs

High-tech motor Spindles

Best surface finish for both roughing and finishing

The high-performance Spindles from Step-Tec are designed to do heavy roughing and Milling to best surface finish all in one. With a bearing design with three preloaded hybrid ball bearings in the front and a thermally robust hybrid cylindrical roller bearing on the back, you are guaranteed a super-rigid rotating system that enables Milling with extra-long tools reaching into deep cavities. Ramp up your chip removal, thanks the feed rates made possible by this solution's absorption of high Milling forces at the tool tip.

Incorporated into the **HPC190** line is the well-proven OptiCool principle that keeps the front bearing area cool while the extra heat barrier cooling loop keeps the motor heat away from the Spindle nose. That results in a thermally balanced Spindle thus assuring a high level of precision, repeatability and surface finish.

Spindle HPC190

Power (S6)	36 kW
Torque (S6)	120 Nm
Speed max.	20,000 rpm
Acceleration	2.5 s
Lubrication	Oil - air
Tool interface	HSK-A63 DIN69063-1

- Direct Lubricating System (DLS) oil-air bearing lubrication through outer race
- Fully digital Spindle equipped with every conceivable sensor to support smart machine integration
- Through-Spindle cooling featuring rotary unions fed by all known liquid and gaseous media
- Machine and Spindle Protection (MSP) crash-proof system to protect your machine and Spindle



— S1
— S6 40% ED ts=2 min.

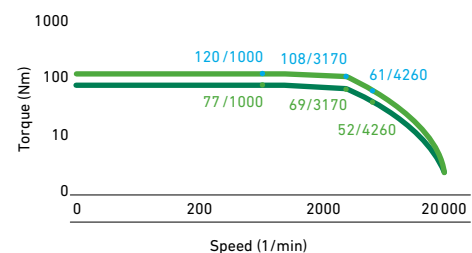
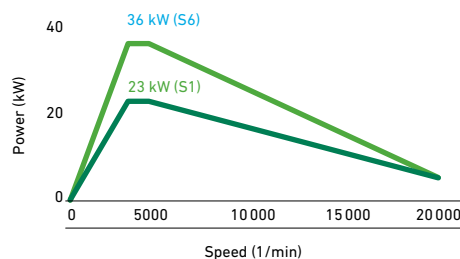

The 36,000 rpm **HVC150** Spindle is the optimum solution for mold and die machining. It reaches a superb surface finish thanks to its great axial stability. Due to the specially chosen bearing arrangement with two hybrid ball bearings in the rear instead of the common roller bearing system, this Spindle stands out with very low dynamic axial growth. This precision bearing arrangement offers the best in repeatability for machining operations.

Spindle HVC150

Power (S6)	33 kW
Torque (S6)	21.3 Nm
Speed max.	36,000 rpm
Acceleration	2.5 s
Lubrication	Oil - air
Tool interface	HSK-E50 DIN69063-1

- Good thermal stability through OCS
- Excellent weight/performance ratio
- Integrated intelliSTEP functionality



— S1
— S6 40% ED ts=2 min.

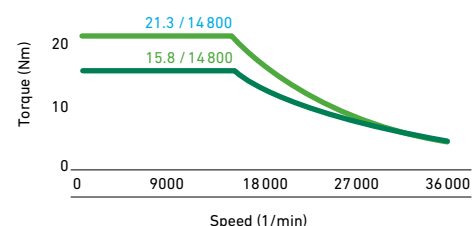
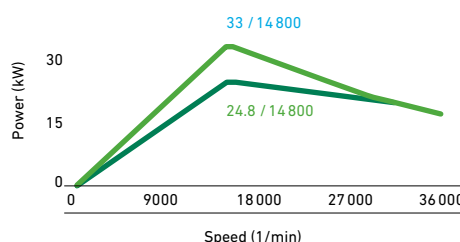

Space
for performance

Step-T
Switzerland



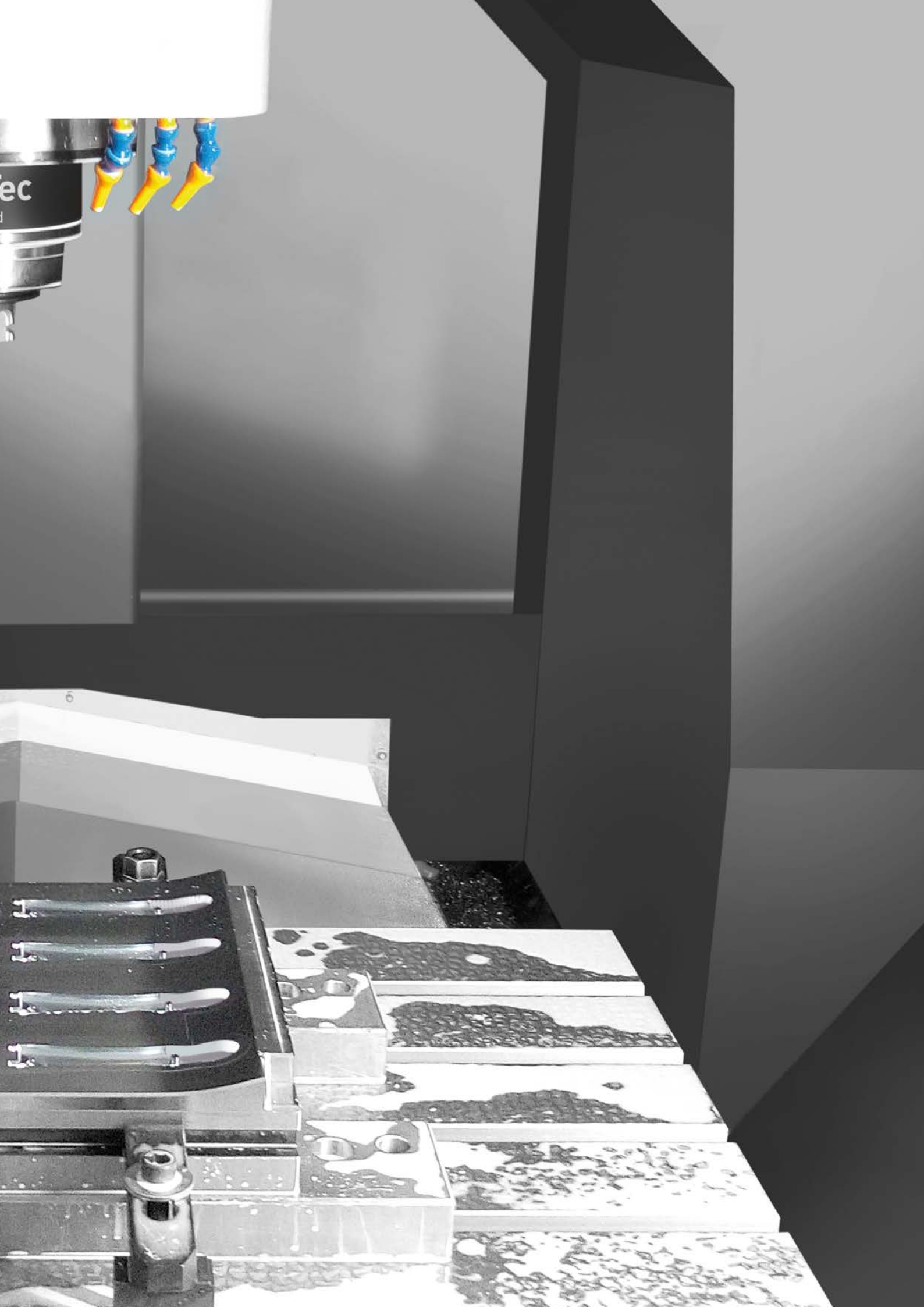

Tool magazines

Choice of solutions to meet your needs

Tool magazine for every need

- Disc-type or chain magazine
- Capacity of up to 60 tools with a magazine internal to the machine's standard footprint
- Touch probe orientation

- Ergonomic and user friendly
- Ensure productivity and process reliability
- Parallel machining and tool loading
- Easy tool loading possibilities thanks to an ergonomic tool loading door

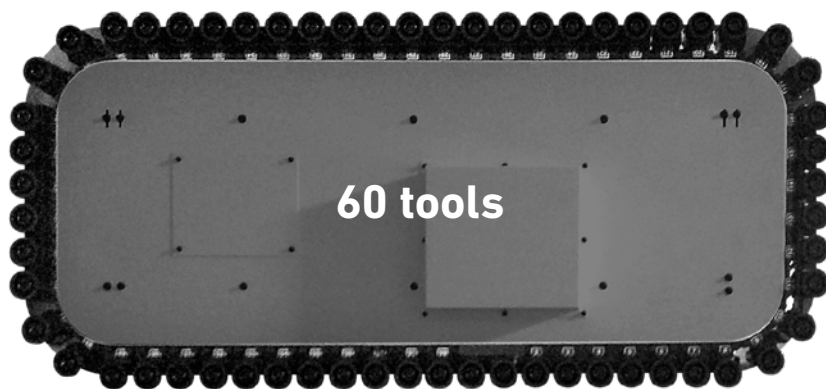

Chip management

Wet or dry – clean machining

Customer benefits

- Optimum chip flow to steep and smooth cabin walls
- Wash-down nozzles for all corners to prevent chip accumulation
- Large and strong chip augers to transport high volume of chips



Adapted chip management



- Solution for high-volume aluminum Milling chips with slat band lift-up chip conveyor and coolant unit with fine filtration
- Solution for high-volume steel Milling chips with scraper lift-up chip conveyor and coolant filtration unit

Options

- Through-Spindle coolant
- Wash-down system
- Coolant thermal control
- Oil skimmer



Automation with pallet magazine

Lower your costs, increase productivity with Automation

Take your productivity to new levels while reducing your costs with our superior Automation solution. The Pallet Magazine generously dimensioned door allows optimum pallet access for loading light parts by hand and heavy parts by crane. Larger windows allow a good view into the pallet area, and pallets are managed by using the machine control.

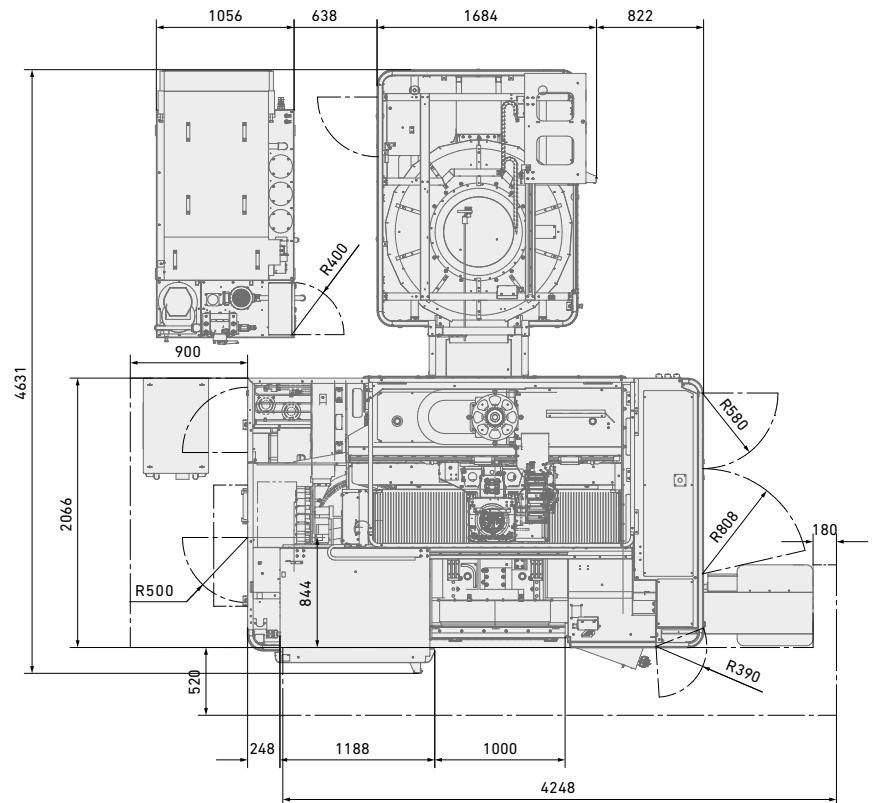

Configuration as System 3R

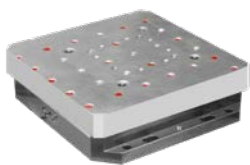

Pallet Automation **5 Delphin 400 x 400**

Pallet changing time 30 s

Max. payload 200 kg

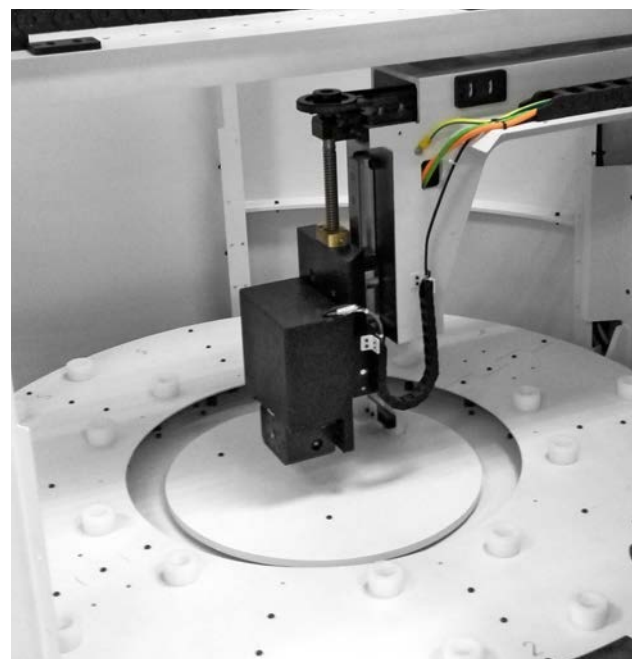

Ergonomic door design for easy loading of parts up to 200 kg

The logo for Step-Tec Switzerland, featuring the brand name in a bold, sans-serif font with 'Switzerland' in a smaller font below it. The logo is positioned on the black upper housing of the robotic arm.

Step-Tec
Switzerland

A photograph of an industrial robotic cell. In the foreground, a robotic arm with blue and yellow joints is positioned over a grey, octagonal worktable. The background shows the interior of the cell with various mechanical components and a large metal door. The scene is lit with bright, overhead lights, creating a clean and professional atmosphere.

Automation from the back,
full access on the front

Our Service + Success range

We take you to new heights

Guiding your ascent

Whether it is Milling, EDM, Laser Texturing or Additive Manufacturing, our Service + Success experts guide you throughout the entire lifecycle of our Machining and Automation tools in order to help you reach your peak performance. Our trusted experts backed by our latest cutting-edge, intelligent Digital Solutions, provide a **full range of services**.



Operational steering
Hands-on and operational service interventions with supply of consumables and wear parts



Advanced diagnosis
Machine check-up, preventive maintenance and advanced services including original spare parts availability in all our hubs around the world



Certification
State-of-the-art reference by industry sector and on machining equipment



Upgrades
Designed to add value to the original machine investment in order to achieve higher sustainable productivity



Training
Performance oriented academy with a human-centric approach of knowledge transfer in order to realize the full potential of our solutions



Transformation
Strategic partnership from made-to-measure advice on business model evolution to industrial implementation



Financial solutions
For the optimization of operating costs featuring minimal initial expenditure programs and leasing options

Our Success Packs

As a long-time partner, since 1802 we have been serving various industrial segments and have been dedicated to providing you with a first-in-class combination of services.

We have conceived our new Success Packs range for maximizing **your return on investment**, empowering you in your quest for success whatever your industrial profile.



Silver +
Secure
your future



Silver
Set the foundation
for growth



Bronze +
Achieve flawless
production



Bronze
Get back on
track fast



Options

Multiple options to drive your success

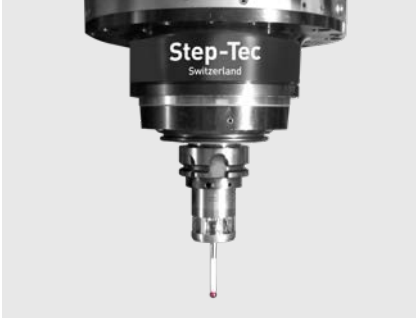

Infrared touch probe



Laser measuring system



Through-Spindle cooling



External coolant supply



Wash-down system



Band filter system



Rotary viewing window



Machine and Spindle Protection (MSP)

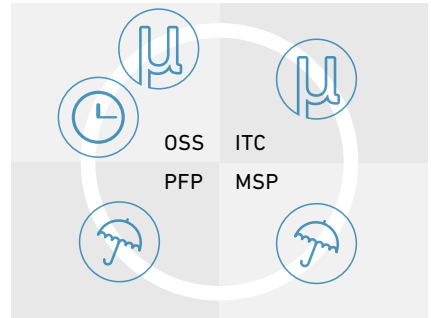

smart machine



Fanuc or Heidenhain control

Customer Services

New digital service possibilities

GF Machining Solutions Customer Services continues to push technological boundaries to deliver the future of services to you—today.



rConnect provides a digital services platform for all GF Machining Solutions technologies. This modular system includes a range of services – all backed by TÜViT-certified cybersecurity – to increase your manufacturing productivity.

rConnect Messenger lets you track production status with machine data updates on your mobile device. Monitor your entire shop and maximize your productivity from anywhere in the world, right on your smartphone.

rConnect Live Remote Assistance (LRA) enables our expert engineers to help you maximize machine uptime with quick responses to your service requests through audio, video chat and more.



Technical data



MILL P 900

Axis travel

Longitudinal X	mm (in)	900 (35.43)
Lateral Y	mm (in)	600 (23.62)
Vertical Z	mm (in)	450 (17.71)

Travel speed

Rapid traverse X	m/min (ipm)	30 (1,181)
Rapid traverse Y	m/min (ipm)	30 (1,181)
Rapid traverse Z	m/min (ipm)	30 (1,181)

Tool Spindle (40% ED, S6)

20,000 min ⁻¹ , HSK-A63 S6	kW / Nm	36 / 120
36,000 min ⁻¹ , HSK-E50 S6	kW / Nm	33 / 21.3

Work table

Pallet/clamping surface	mm (in)	Chuck Delphin 400 x 400 (15.75 x 15.75)
Max. table load	kg (lbs)	1,000 (2,204)

Tool magazine

HSK-A63 tool holder		DT 30 / CT 60
HSK-E50 tool holder		DT 30 / CT 60

Automation

Pallet size / Number	mm / piece (in / piece)	Delphin 400 x 400 / 5 (Delphin 15.75 x 15.75 / 5)
Maximum additional load	kg (lbs)	200 (441)

Weight

Machine	kg (lbs)	12,000 (26,455) with CT60
Pallet changer	kg (lbs)	1,455 (3,207)

Control

Heidenhain		TNC 640
Fanuc		Fanuc 31i-B

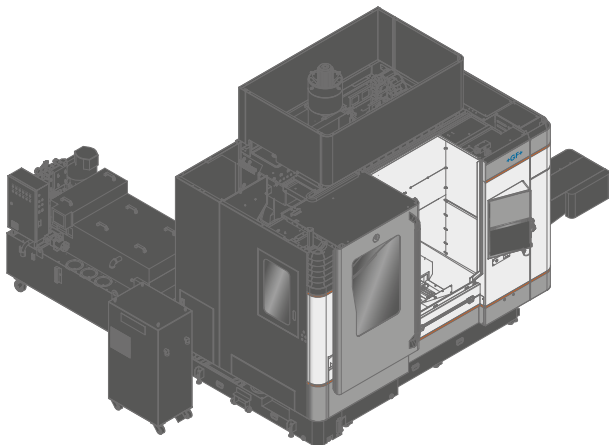
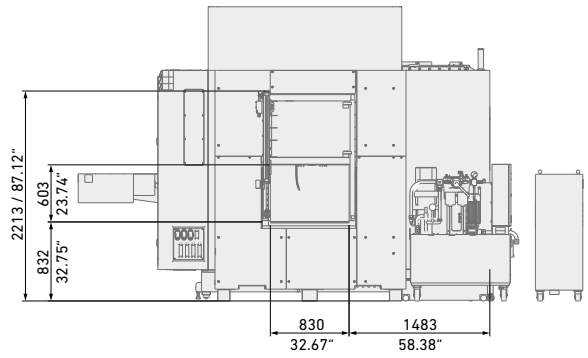
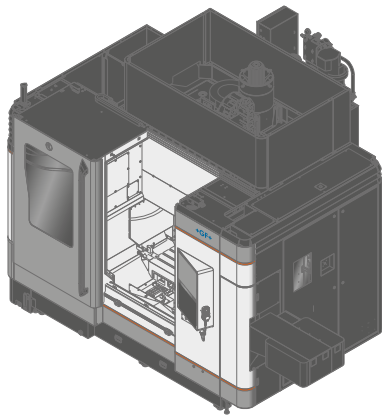
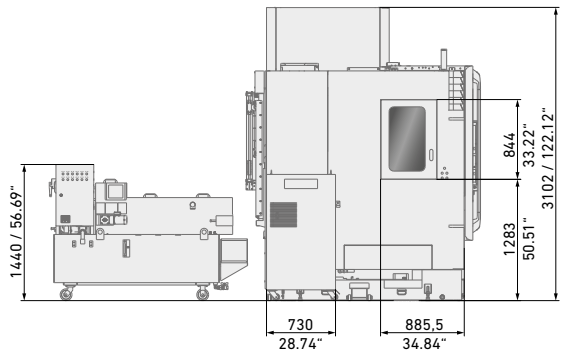
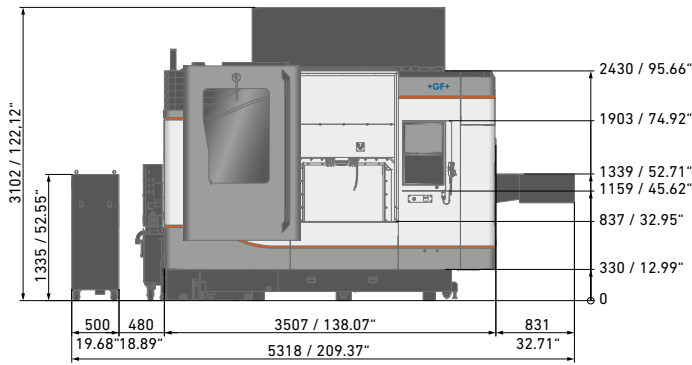
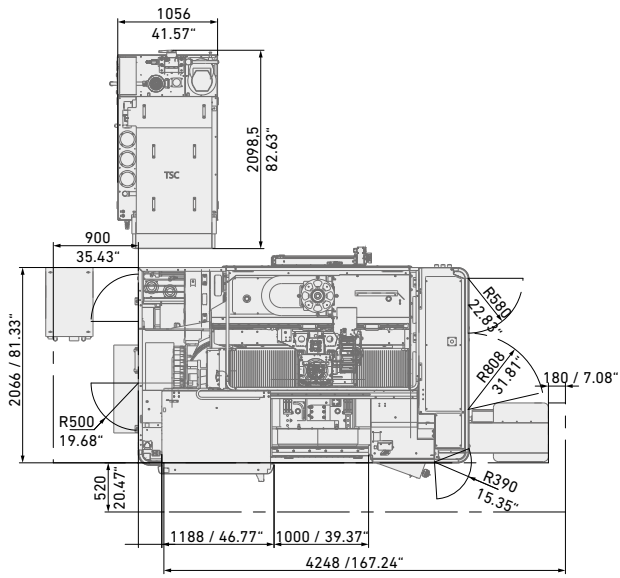

About GF Machining Solutions

Multi-technology solutions provider

Our commitment to you and your specific applications is proven by the value-adding intelligence, productivity and quality delivered by our multi-technology solutions. Your success is our chief motivator. That's why we are continuously advancing our legendary technical expertise. Wherever you are, whatever your market segment and whatever the size of your operation, we have the complete solutions and the customer-centric commitment to accelerate your success—today.

EDM (Electrical Discharge Machining)



Wire-cutting EDM

GF Machining Solutions' wire-cutting EDM is fast, precise and increasingly energy efficient. From ultraprecise machining of miniaturized components down to 0.02 mm to powerful solutions for demanding high-speed machining with respect to surface accuracy, our wire EDM solutions position you for success.

Die-sinking EDM

GF Machining Solutions is revolutionizing die-sinking EDM with features like iGAP technology to dramatically boost machining speed and reduce electrode wear. All of our die-sinking systems offer fast removal and deliver mirror finishes of Ra 0.1 µm (4 µin).

Hole-drilling EDM

GF Machining Solutions' robust hole-drilling EDM solutions enable you to drill holes in electrically conductive materials at a very high speed—and, with a five-axis configuration, at any angle on a workpiece with an inclined surface.

Tooling and Automation



Tooling

Our customers experience complete autonomy while maintaining extreme accuracy, thanks to our highly accurate System 3R reference systems for holding and positioning electrodes and work pieces. All types of machines can easily be linked, which reduces set-up times and enables a seamless transfer of workpieces between different operations.

Automation

Together with System 3R, we also provide scalable and cost-effective Automation solutions for simple, single machine cells or complex, multi-process cells, tailored to your needs.

Milling



Milling

Precision tool and mold manufacturers enjoy a competitive edge with our Mikron MILL S solutions' fast and precise machining. The Mikron MILL P machines achieve above-average productivity thanks to their high performance and Automation. Customers seeking fastest return on investment benefit from the affordable efficiency of our MILL E solutions.

High Performance Airfoil Machining

Our Liechti turnkey solutions enable the highly dynamic manufacturing of precision airfoils. Thanks to the unique performance and our expertise in airfoil machining, you increase productivity by producing at the lowest cost per part.

Spindles

As part of GF Machining Solutions, Step-Tec is engaged in the very first stage of each machining center development project. Compact design combined with excellent thermal and geometric repeatability ensure the perfect integration of this core component into the machine tool.

Software



Digitalization solutions

To drive its digital transformation, GF Machining Solutions acquired symmedia GmbH, a company specialized in software for machine connectivity. Together, we offer a complete range of Industry 4.0 solutions across all industries. The future requires the ability to adapt quickly to continual digital processes. Our intelligent manufacturing offers embedded expertise, optimized production processes, and workshop Automation: solutions for smart and connected machines.

Advanced manufacturing



Laser texturing

Aesthetic and functional texturing is easy and infinitely repeatable with our digitized Laser technology. Even complex 3D geometries, including precision parts, are textured, engraved, microstructured, marked and labeled.

Laser micromachining

GF Machining Solutions offers the industry's most complete line of Laser micromachining platforms optimized for small, high-precision features to meet the increasing need for smaller, smarter parts to support today's leading-edge products.

Laser Additive Manufacturing (AM)

GF Machining Solutions and 3D Systems, a leading global provider of additive manufacturing solutions and the pioneer of 3D printing, have partnered to introduce new metal 3D printing solutions that enable manufacturers to produce complex metal parts more efficiently.

Service + Success



We take you to new heights

Our Success Packs are designed to maximise your return on investment and empower you in your quest for success across all industrial segments. Our subscription packs feature a comprehensive range of services that guarantee the access and support you need to get the most out of your assets today, while preparing for the challenges of tomorrow. Our trusted experts backed by our latest cutting-edge, intelligent Digital Solutions, provide a full range of services.



Switzerland

Biel/Bienne
Losone
Geneva
Flawil
Langnau

www.gfms.com
www.gfms.com/ch

Europe

Germany, Schorndorf
www.gfms.com/de

United Kingdom, Coventry
www.gfms.com/uk

Italy, Agrate Brianza - MI
www.gfms.com/it

Spain, Sant Boi de Llobregat
Barcelona
www.gfms.com/es

France, Palaiseau
www.gfms.com/fr

Poland, Raszyn / Warsaw
www.gfms.com/pl

Czech Republic, Brno
www.gfms.com/cz

Sweden, Vällingby
www.gfms.com/system3r

Turkey, Istanbul
www.gfms.com/tr

Americas

USA
Lincolnshire, IL
Chicago, IL
Holliston, MA
Huntersville, NC
Irvine, CA
Woodridge, IL
www.gfms.com/us

Canada, Mississauga ON
www.gfms.com/us

Mexico, Monterrey NL
www.gfms.com/us

Brazil, São Paulo
www.gfms.com/br

Asia

China
Beijing, Shanghai,
Chengdu, Dongguan,
Hong Kong, Changzhou
www.gfms.com/cn

India, Bangalore
www.gfms.com/sg

Japan
Tokyo, Yokohama
www.gfms.com/jp

Korea, Seoul
www.gfms.com/kr

Malaysia, Petaling Jaya
www.gfms.com/sg

Singapore, Singapore
www.gfms.com/sg

Taiwan
Taipei, Taichung
www.gfms.com/tw

Vietnam, Hanoi
www.gfms.com/sg

At a glance

We enable our customers to run their businesses efficiently and effectively by offering innovative Milling, EDM, Laser, Additive Manufacturing, Spindle, Tooling and Automation solutions. A comprehensive package of services completes our proposition.

www.gfms.com



© GF Machining Solutions Management SA, 2022
The technical data and illustrations are not binding.
They are not warranted characteristics and are
subject to change.