

AgieCharmilles

FORM X

400
600



Becoming better every day – since 1802

GF Machining Solutions

When all you need is everything, it's good to know that there is one company that you can count on to deliver complete solutions and services. From unmatched Electrical Discharge Machining (EDM), Laser texturing, Laser micromachining, Additive Manufacturing and first-class Milling and Spindles to Tooling and Automation, all of our solutions are backed by unrivaled customer service and expert GF Machining Solutions training. Our AgieCharmilles, Microlution, Mikron Mill, Liechti, Step-Tec and System 3R technologies help you raise your game—and our digital business solutions for intelligent manufacturing, offering embedded expertise and optimized production processes across all industries, increase your competitive edge.



+ We are AgieCharmilles.
We are GF Machining Solutions.

Contents

4	Highlights
6	The mechanics
10	AC FORM HMI
12	The generator
14	Autonomy and flexibility
18	Technical data
22	GF Machining Solutions

Fast, intelligent and accurate

Set new performance benchmarks with the intelligent and easy-to-integrate FORM X 400 and FORM X 600, delivering positioning accuracy within 1 μm , and general machining accuracy on the workpiece down to 5 μm .

Highlights

EDMASTER for highest accuracy, speed and automation



The FORM X 400 and FORM X 600 combine multiple elements dedicated to the most accurate product production. As a master of accuracy and speed, it is no surprise that GF Machining Solutions has mastered every detail in the FORM X 400 and FORM X 600, from the generator components and the human-machine Interface (HMI) to the numerical control, mechanical concept and Automation. The unparalleled performance of the FORM X 400 and FORM X 600 ensure a new degree in competitiveness due to their simplification and Automation of the highly technical processes around the production of molds and components.

With the FORM X 400 and FORM X 600, deep know-how is integrated and application success is programmable at the touch of a finger. This ease of use is especially important in microelectronics, telecommunications, medtech, connectors and optical systems.





AC FORM HMI: perfect results at your fingertips

The ergonomics of GF Machining Solutions' new AC FORM HMI put customers in the driver's seat by making die-sinking EDM an intuitive, easy-to learn and easy-to-use process. That means greater autonomy over your processes, higher efficiency, improved process reliability and accelerated performance. The standardized working environment created by the AC FORM HMI makes it easy to achieve perfect machining results.

Remote control menus adapted to operator tasks

To allow the operator to adapt the remote control to the manual task at hand, a menu is provided for configuring the icons displayed on the remote control display. In addition to standard icons, this menu allows the operator to define semi-automatic movements or specific measuring cycles during the manual process. This is one of many AC FORM HMI features that put greater flexibility and efficiency at the operator's fingertips.

The mechanics

A reliable, long-lasting mechanical concept

The structure adopted includes a frame of polymeric material, with fixed worktable, ideal for loading heavy workpieces as well as for Automation of rapid workpiece/electrode change operations.

As work area ergonomics are an important factor in productivity, this structure has been specially designed to allow access on three sides even in the case of a high capacity electrode changer. The spheroidal cast iron XYZ axes located in the upper part of the machine are based on highly accurate calculations in order to reduce their mass and at the same time meet requirements in terms of rigidity, precision and dynamic conditions associated with the new performance levels of the FORM X 400 and FORM X 600.

These moving parts are fully disassociated from the loading and machining area in order to ensure that they are unaffected by variations in temperature in the erosion area, nor by the extreme range in weights of the workpieces that can be accommodated by the FORM X 400 and FORM X 600.

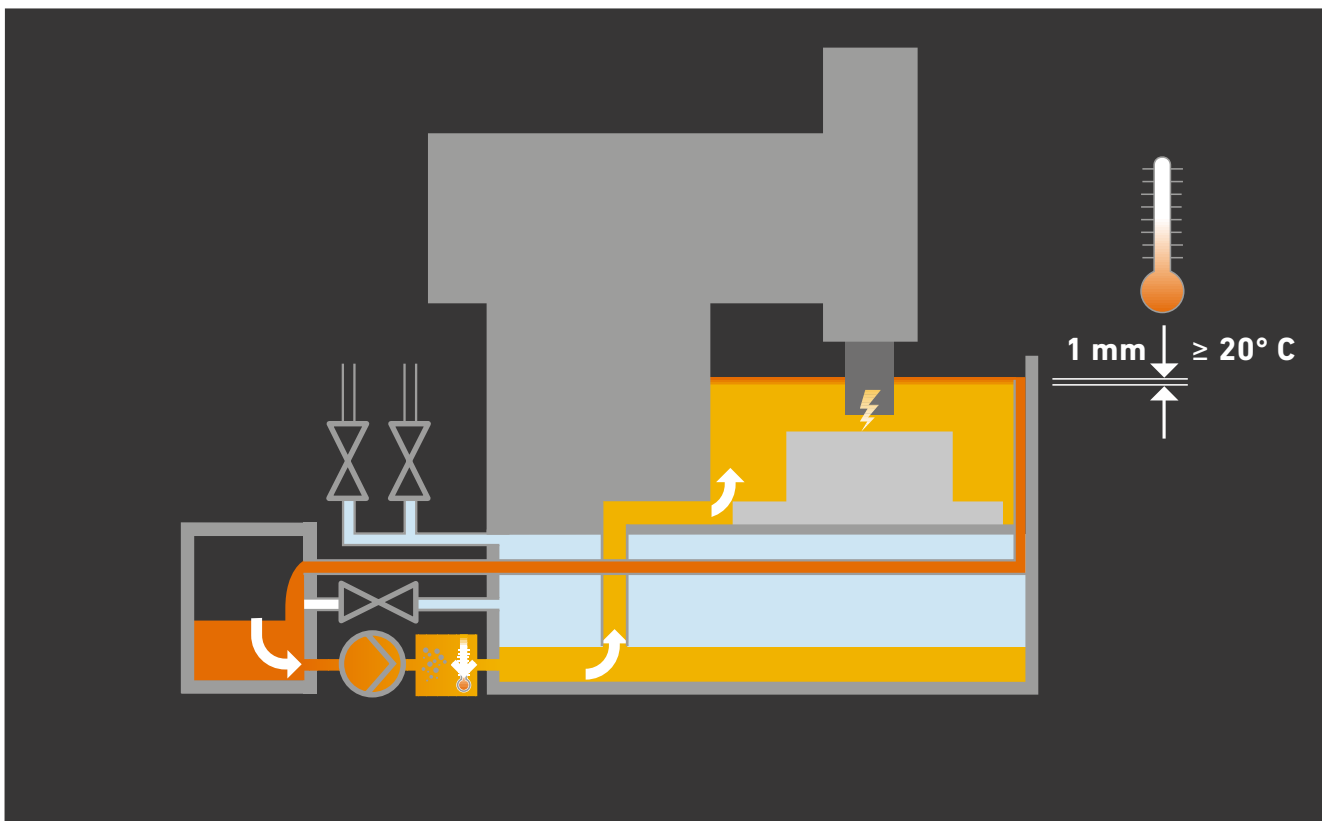



Variation in ambient temperature where the machine is installed and that of its various components can certainly physically affect its static and dynamic geometry and, consequently, the quality and accuracy of the parts produced. As the micron becomes the new measure of precision for this range of machines, such aspects received careful attention in all the various phases of development of the range, thus allowing incorporation of innovative control and isolation solutions to make the FORM X 400 and FORM X 600 machines very much less sensitive to these variations in temperature. As a result, the geometrical accuracy and positioning results are guaranteed to a high degree of certainty.

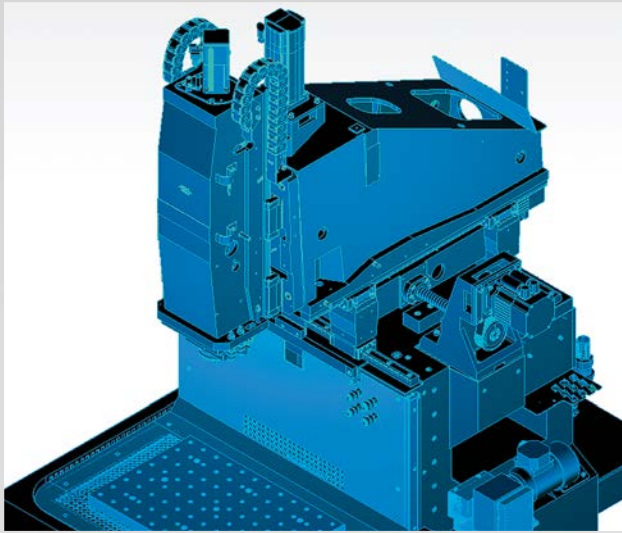

Unique mechanical concept

The FORM X 400 and FORM X 600 die-sinking EDM machines have a unique mechanical structure. The modern solution consists of a machine column made of polymer, a fixed table with an automatically lowerable work tank, allowing easy loading of heavy workpieces, as well as a modular Automation system for loading and unloading workpieces and electrodes.



Mastery of the working temperature

Temperature environment is often subjected to a fluctuation, some time related to the environment or related to the equipment itself. In the interests of maximum thermal stability GF Machining Solutions has been able to master these fluctuations to allow ultimate stability whatever the production rate.

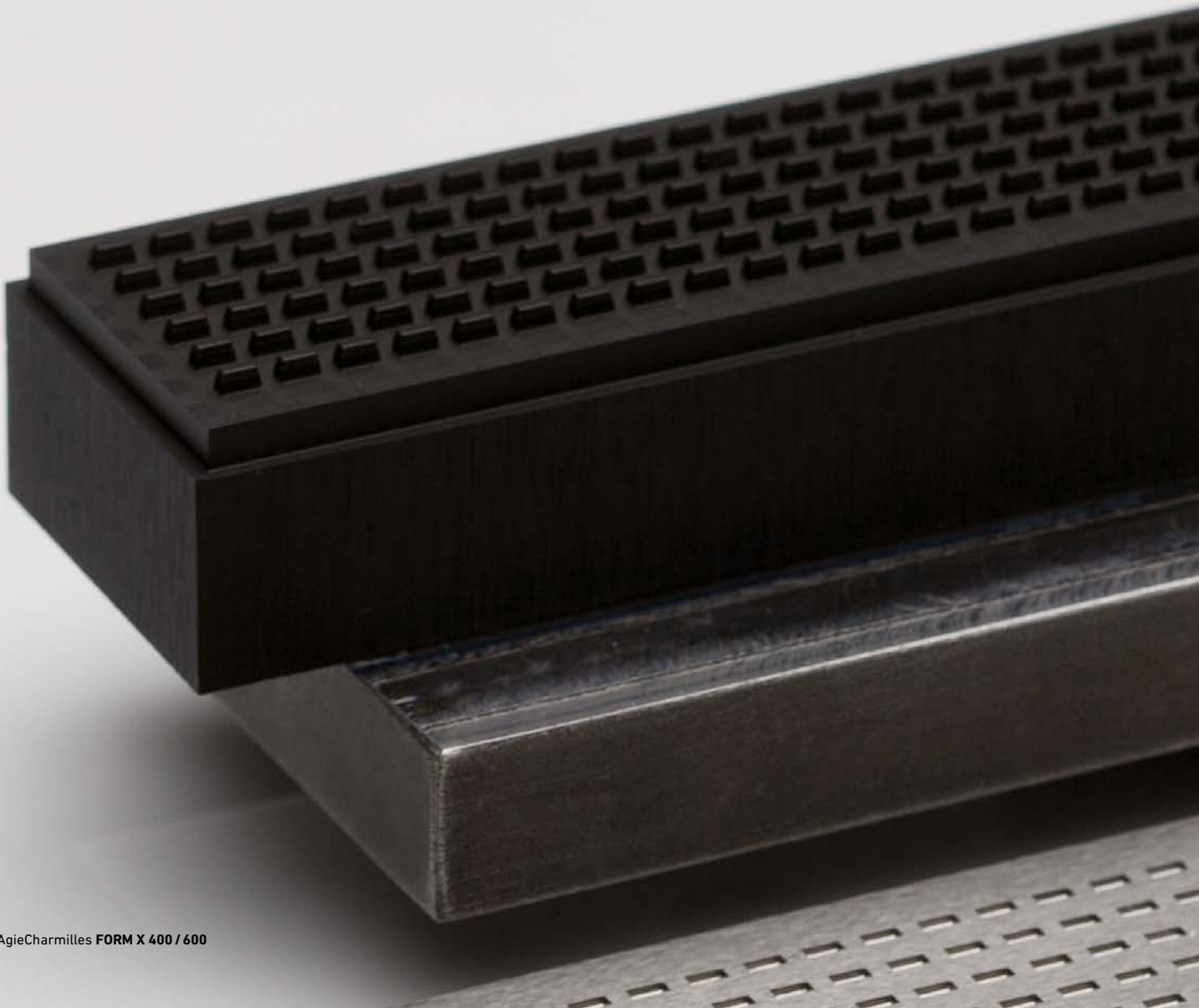

Exceptional positioning accuracy

With accuracy in the μm range on the workpiece, the FORM X 400 and FORM X 600 meet the high demands of mold making. Typical applications are multi-functionally designed plastic parts. These include webs, jaws, apertures and cavities enabling the assembly and secure mounting of electronic components.

Thermo Control: the system for unmatched precision under workshop conditions

The new, sophisticated and unique system compensates for temperature variations. Temperature stabilization is achieved by cooling the X, Y and Z glass scales and the Z axis ball screw with stable temperature dielectric. The thermal expansion of the cast iron X, Y, and Z axes is compensated and absolute precision is achieved.

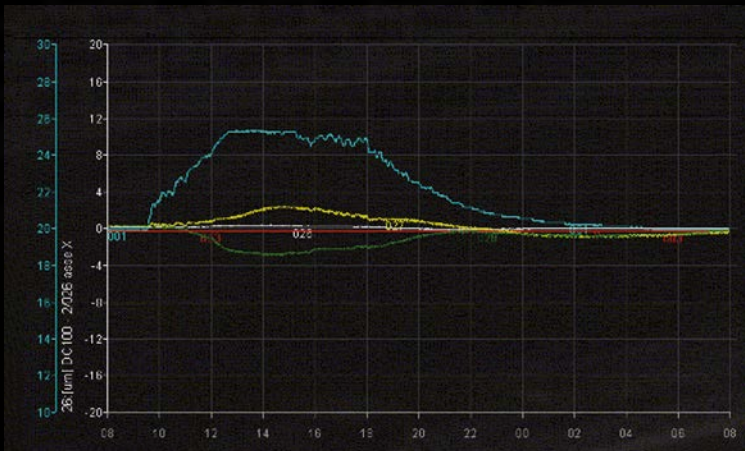

Position accuracy: 24 hours test

- Room temperature
- X axis
- Y axis
- Z axis

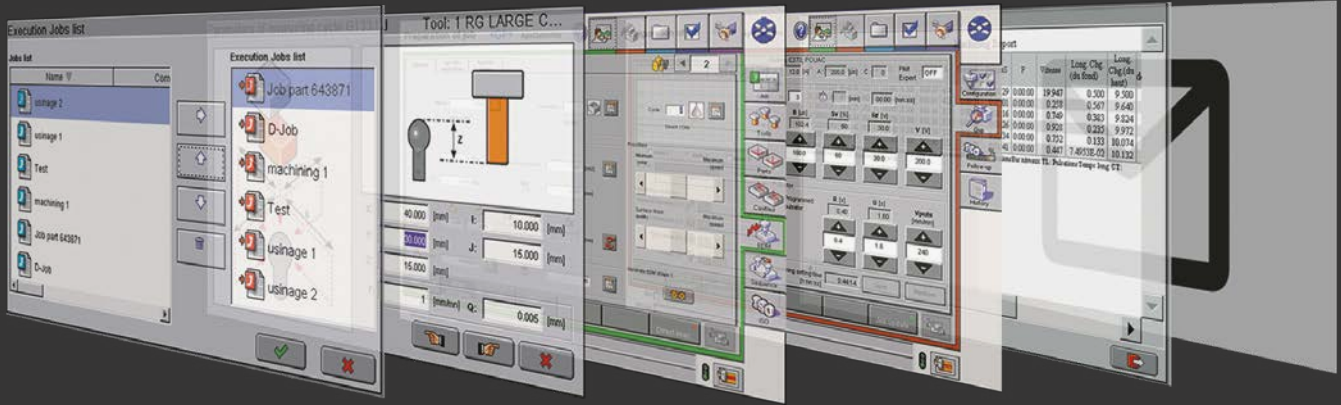

Flexible work organization

Whether on a PC or on the FORM X 400 and FORM X 600 machines, AC FORM HMI offers you job organization according to your priorities.

Measurement of essential offsets and positions

during work preparation: the measurements made on a pre-measurement terminal can be used directly by AC FORM HMI.

Electrodes designed under AC FORM HMI

offer ideal undersize and streamline the number of electrodes necessary for machining.

Machining under AC FORM HMI high surveillance

with Systems EXPERT automated protection, guarantees you results at the height of your requirements.

Control of work executed under AC FORM HMI

automatically creates a report after each machining session. The operator can access it via the network or directly on the machine.

SMS notification

All information related to machining can be transmitted directly to the operator via SMS.

AC FORM HMI

Faster control, in complete security

Dynamic manufacturing process

The development of AC FORM HMI is based on a study carried out with numerous mold makers in order to streamline the mold making technique. The organization and layout of screens are a direct development of the information taken from this study. This user friendliness that has made GF Machining Solutions interfaces so successful has been not only maintained but further developed benefit the mold maker's tasks.

Maximize productive time

Due to the necessity of maximizing productive time, the AC FORM HMI brings new solutions:

- Part Express allows interruption of an operation so that an urgent job can be inserted.
- Job List organizes the order of jobs according to manufacturing priorities.

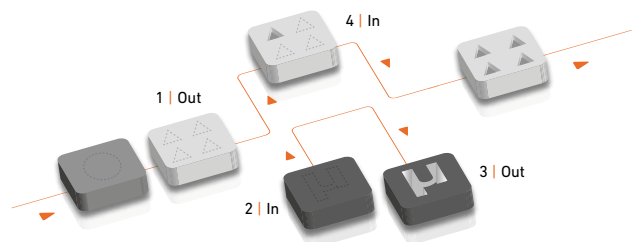

Interactive graphical assistance

All operations, such as measurement, machining or cavity-positioning cycles, are illustrated by graphics/icons, allowing the operator to understand intuitively and spontaneously.

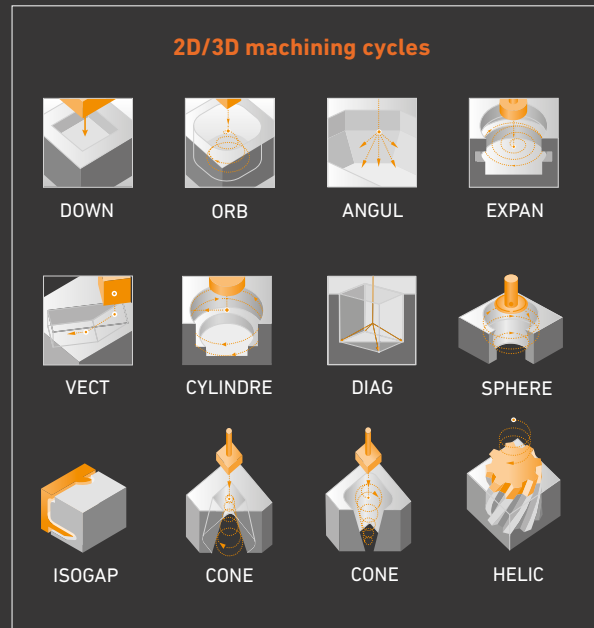
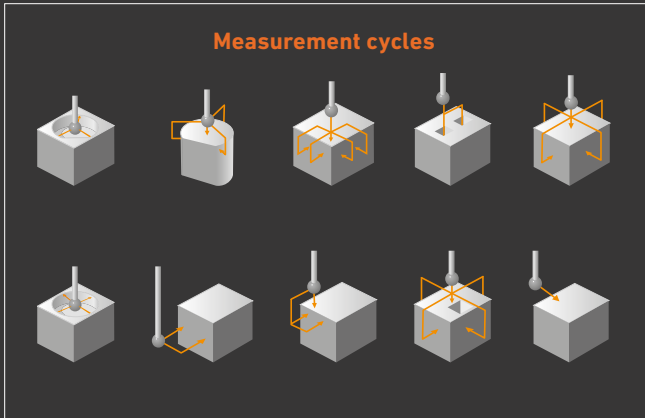

e-Doc

The FORM X 400 and FORM X 600 range incorporate new online help to allow the operator to find relevant information as quickly as possible. This occurs via simplified access to help menus, by having a clearly organized navigation interface that is more user friendly and easy to grasp, and including search by key words or user index. Machining examples are produced as hard copy, presented in a succinct manner.

They are called up by using the online help system, so that implementation of a machining process can be followed stage by stage. More than additional descriptive documentation, e-Doc allows a genuine knowledge transfer for the benefit of the operator, enabling continuous knowledge improvement while reducing working days lost to training.

Automatic CAD/CAM link

The different EDM machining sequences are automatically integrated into AC FORM HMI.

Platform: Windows

- Integral PC
- Touch screen
- CD-ROM drive
- USB port
- Network connection



The generator

A highly flexible numeric generator

The ISPG generator, with fully digital data input, ensures a very high degree of predictability and repeatability of the machining results, even when executing the most complex shapes. The new generator incorporates a new technology, developed in our laboratories, that transports the lowest current levels of the generator to the erosion area, allowing a considerable increase in performance in the finishing phases with decidedly higher machining speeds and higher standards in surface finish, appreciable decreases in the residual altered layer and previously unimaginable rates of wear. Companies working in the world of miniaturization will find a great ally in the FORM X 400 and FORM X 600 and their modern generator.

The new type of digitally shaped pulses (DSP) and the highly automated machining strategies can easily carry out the various machining operations with no trouble using electrodes just a few tenths of a millimeter in size, regardless of their material. In this type of application, the tiniest of geometries must be reproduced with absolute perfection to guarantee the quality of the end products. The FORM X 400 and FORM X 600 yield impressive results on the most challenging micro applications, including very small inner radii.

High resolution parameters for current and voltage, and a high precision servo system with response times in the range of milliseconds enable machining with smallest internal radii.

Lowest-wear EDM

These new possibilities offered by generator represent significant progress in die-sinking EDM and pave the way for completely new and attractive potential for customers manufacturing dies and components for a whole range of industrial sectors: they tower above their competitors because they can do more and better.

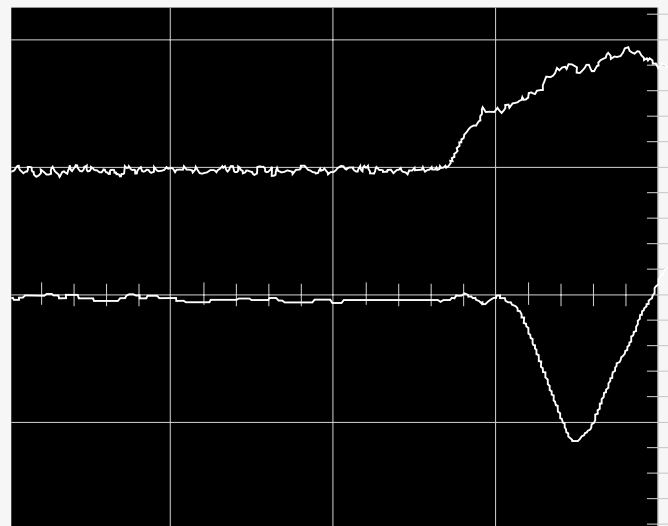

The iQ (innovative Quality) technology developed by GF Machining Solutions is available for the FORM X 400 and FORM X 600. Our iQ technology allows low-wear EDM with graphite and copper electrodes, reducing electrode consumption and related costs while guaranteeing the highest accuracy of form.



Part material: Steel 1.2343
 Electrode material: Graphite R8710
 Number of electrodes: 2
 Number of simple forms: 7
 Machining depth: 9 mm
 Roughness: VDI 19, Ra 0.9 µm
 Electric discharge machining time: 88 minutes
 Average linear wear: 7 µm



Part material: Steel 1.2343
 Electrode material: Copper
 Under measure: 0.56 mm
 Machining depth: 20 mm
 Roughness: VDI 26, Ra 1.8 µm
 Result with iQ technology (total time): 5 h 21 min.
 Reduction in wear: from 20 % to 90 %

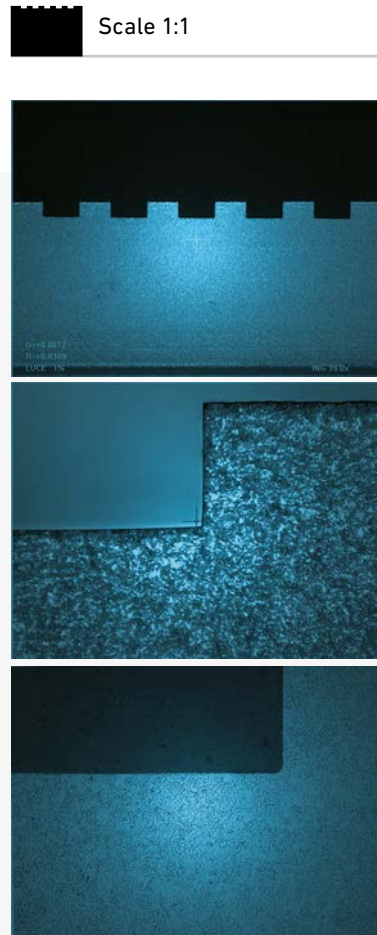
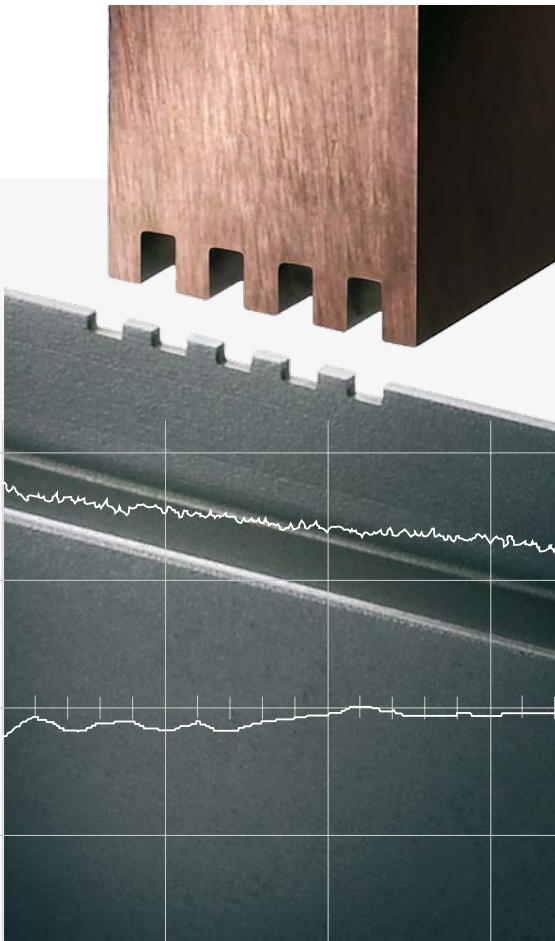

Autonomy and flexibility

Configurable performance potential



Increased autonomy without manual intervention

Manufacturing a mold often requires a large number of electrodes and pallets with sparking times varying noticeably from one cavity to another. GF Machining Solutions offers a large variety of automation solutions allowing large storage capacity, positioning your business for unlimited machining potential.

Tool changer

The electrode changer comes in three versions, for quantities ranging from 20 to 140 electrodes. Maximum flexibility is to be found in the "Capacity 3" version, allowing adaptation of the quantity of electrodes at any time in relation to customers' needs. Thus it is possible to start off with an electrode changer having three 20-electrode discs for a total of 60 electrodes, and then increase to seven 20-electrode discs to get a maximum total of 140 electrode positions.

Capacity 1

One rotary disc for 20 electrodes with standard chuck or 30 electrodes with Combi chuck

Capacity 2

Two rotary discs for 40 electrodes with standard chuck or 60 electrodes with Combi chuck

Capacity 3

Three to seven rotary discs for 60 to 140 electrodes with standard chuck or 90 to 210 electrodes with Combi chuck



Get on the fast track to superior quality

GF Machining Solutions eTracking software platform, linked with the computer numerical control (CNC) of EDM machines, help trim costs by reducing the number of rejected parts and focusing on post-machining control of suspect parts. Our eTracking software helps you establish standard machining methodology from the start, lays a foundation for machining quality, and creates a data record for certification of quality production.

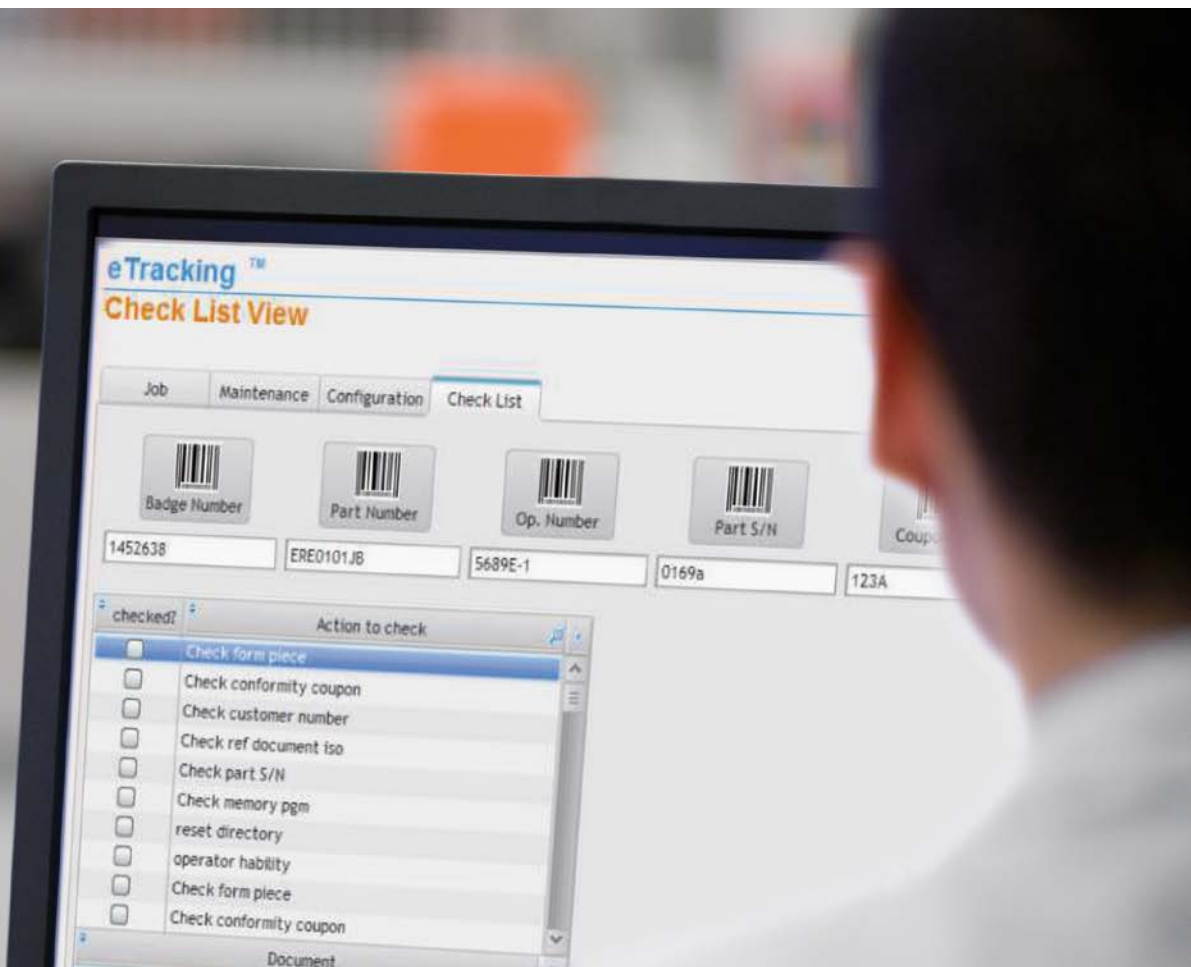
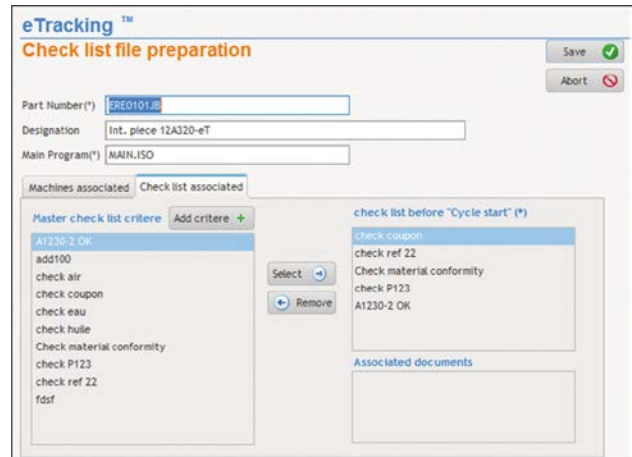



Accura-C, the best high-performance axis on the market

It is not unusual to be confronted by machining situations where the electrodes are incorrectly located, even by such a distance that maintaining their position or stability during machining becomes problematic. Pulsation-induced movements in a liquid (dielectric) medium generate lateral forces (flexural or rotational) on the electrode, which must be resisted by the C axis. Thanks to its very robust design, the Accura-C allows very high moments of inertia to be absorbed, up to 5,000 kgcm².

Renishaw probe

To ensure positioning precision, an optical transmission probe can be managed by the FORM X 400 and FORM X 600. Measurement allows dimensional inspection of machined cavities as well as the taking of references of the part, without having to remove it, for considerable time savings. Furthermore, a measurement report is automatically generated by AC FORM HMI enabling rigorous checking and monitoring.

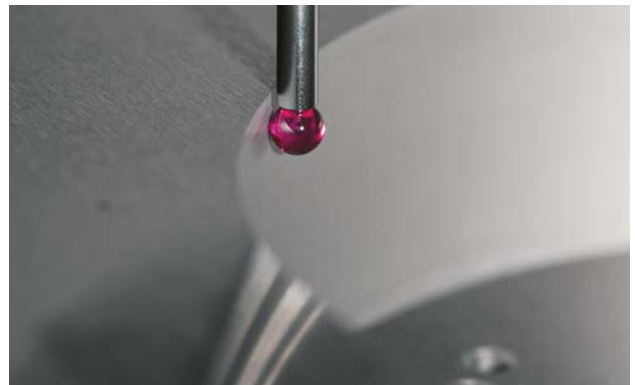

Technical data



FORM X 400

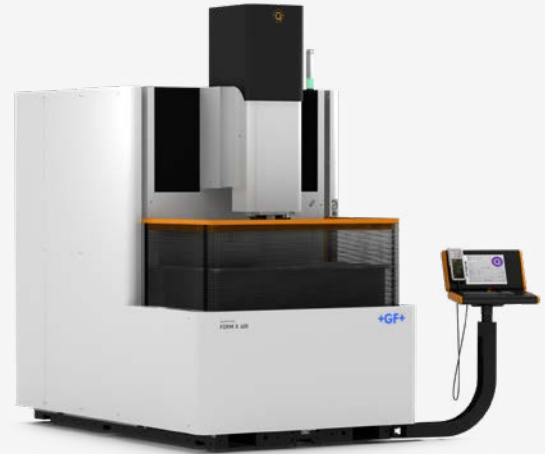

FORM X 600

		FORM X 400	FORM X 600
Machine			
Architecture		C-frame/Fixed table/Drop tank	C-frame/Fixed table/Drop tank
Machine dimensions *	mm (in)	1410 x 2460 x 2600 (55.5 x 96.8 x 102.4)	1790 x 2860 x 3100 (70.5 x 112.6 x 122.1)
Weight total without dielectric	kg (lbs)	3830 (8444)	5504 (12134)
Floor space **	mm (in)	3400 x 4400 (133.86 x 173.23)	3800 x 4800 (149.61 x 188.98)
X, Y, Z axes			
X, Y, Z travel	mm (in)	400 x 300 x 350 (15.7 x 11.8 x 13.8)	600 x 400 x 500 (23.6 x 15.7 x 19.7)
X, Y, axes speed	m/min (ft/min)	6 (19.68)	6 (19.68)
Z axis speed	m/min (ft/min)	15 (49.21)	15 (49.21)
Positioning resolution X, Y, Z	µm (µin)	0.1 (3.94)	0.1 (3.94)
Work area			
Worktank size *	mm (in)	900 x 630 x 350 (35.43 x 24.80 x 13.78)	1280 x 860 x 450 (50.39 x 33.86 x 17.72)
Worktable size **	mm (in)	600 x 400 (23.62 x 15.75)	850 x 600 (33.46 x 23.62)
Distance floor to clamping level	mm (in)	1000 (39.37)	1000 (39.37)
Min./Max. distance between table and chuck	mm (in)	170/520 (6.69/20.47)	200/700 (7.87/27.56)
Workpiece and electrode			
Max. electrode weight	kg (lbs)	50 (110.23)	50 (110.23)
Max. workpiece weight	kg (lbs)	800 (1763.70)	2000 (4409.24)
Max. workpiece dimensions	mm (in)	820 x 580 x 250 (32.28 x 22.83 x 9.84)	1200 x 800 x 350 (47.24 x 31.50 x 13.78)
Bath level	mm (in)	0-290 (0-11.42)	0-390 (0-15.35)
Dielectric unit			
Capacity	l (gal)	490 (129.44)	900 (237.75)
Number of filter elements and type		4 Paper filter cartridges	8 Paper filter cartridges

* Width x depth x height ** Width x depth

		FORM X 400	FORM X 600
Generator			
Generator type		ISPG	ISPG
Max. machining current	A	80 (140 ***)	80 (140 ***)
Best surface finish Ra	µm (µin)	0.08 (2)	0.08 (2)
Electrical supply standard			
Standard voltage		3 x 380 V/400 V ± 10% 50/60 Hz (50 Hz is standard)	3 x 380 V/400 V ± 10% 50/60 Hz (50 Hz is standard)
Cooling			
Heat exchanger air/water for the cabinet		Integrated	Integrated
Heat exchanger dielectricum/water for the dielectricum		Integrated	Integrated
Control Unit			
Operating system		Windows	Windows
Data input		15" LCD screen, mouse or touch screen, keyboard and remote control	15" LCD screen, mouse or touch screen, keyboard and remote control
User interface		AC FORM HMI	AC FORM HMI
Expert systems		TECFORM	TECFORM
Console support		Fixed or movable	Fixed or movable
Modules			
Z axis (15 m/min)		Standard	Standard
Multicavity flushing 6 outputs		Option	Option
3D probe measuring system for Erowa or System 3R		Option	Option
iQ graphite and copper module for reduction of electrodes' wear		Standard	Standard
Tool Changer Capacity 1		20 (Standard)/30 (Combi)	20 (Standard)/30 (Combi)
Tool Changer Capacity 2		40 (Standard)/60 (Combi)	40 (Standard)/60 (Combi)
Tool Changer Capacity 3		Up to 140 (Standard) and 210 (Combi)	Up to 140 (Standard) and 210 (Combi)
Standard C-axis			
Max. electrode weight on automatic chuck	kg (lbs)	25 (55.12)	25 (55.12)
Rotation speed	rpm	0-100	0-100
Max. inertia	kgcm ² (lbsin ²)	1500 (512)	1500 (512)
Accura-C Axis (***)			
Max. electrode weight on automatic chuck	kg (lbs)	25 (55.12)	25 (55.12)
Rotation speed	rpm	0-100	0-100
Max. inertia	kgcm ² (lbsin ²)	5000 (1700)	5000 (1700)

*** Option

FORM X 400

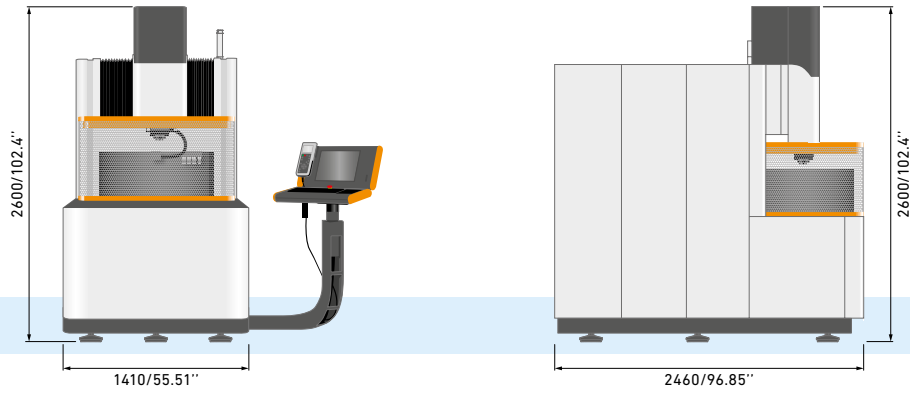

FORM X 400 with electrode changer

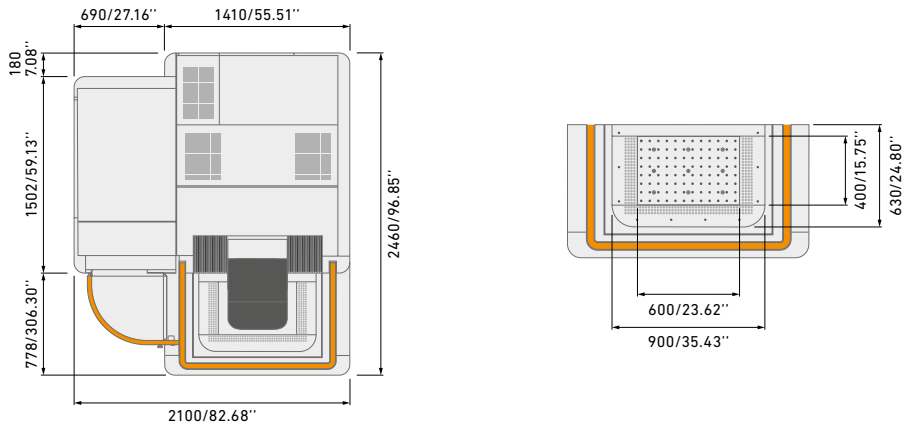

FORM X 600

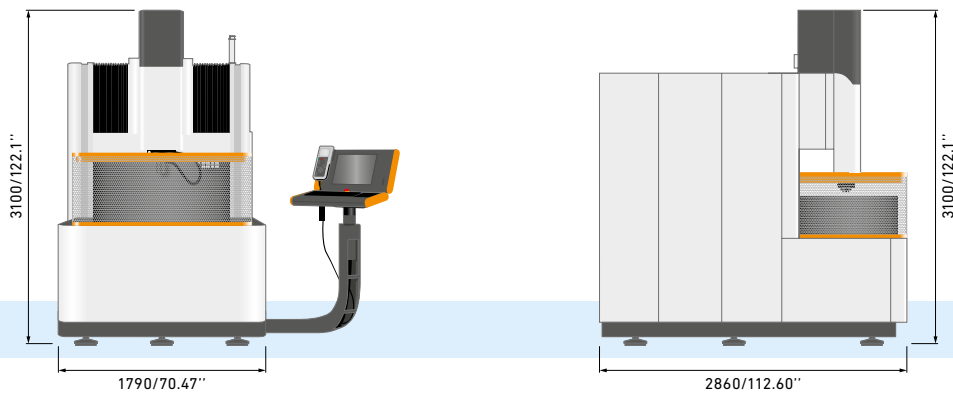

FORM X 600 with electrode changer

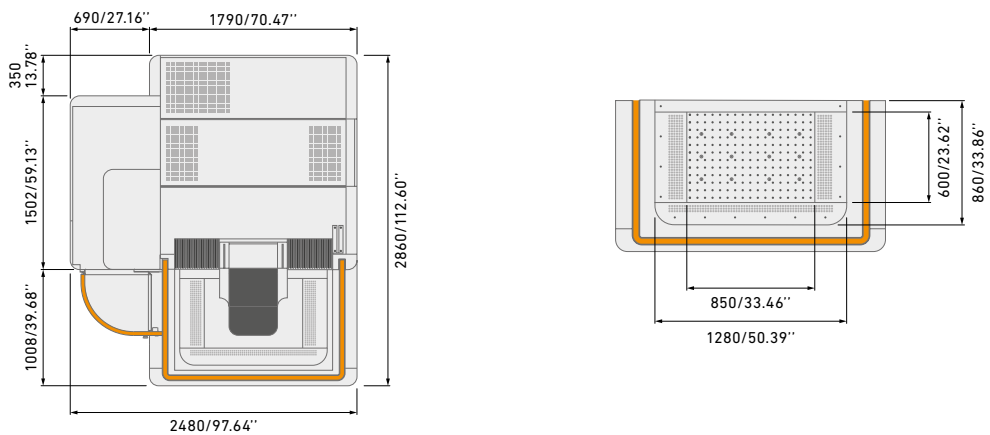

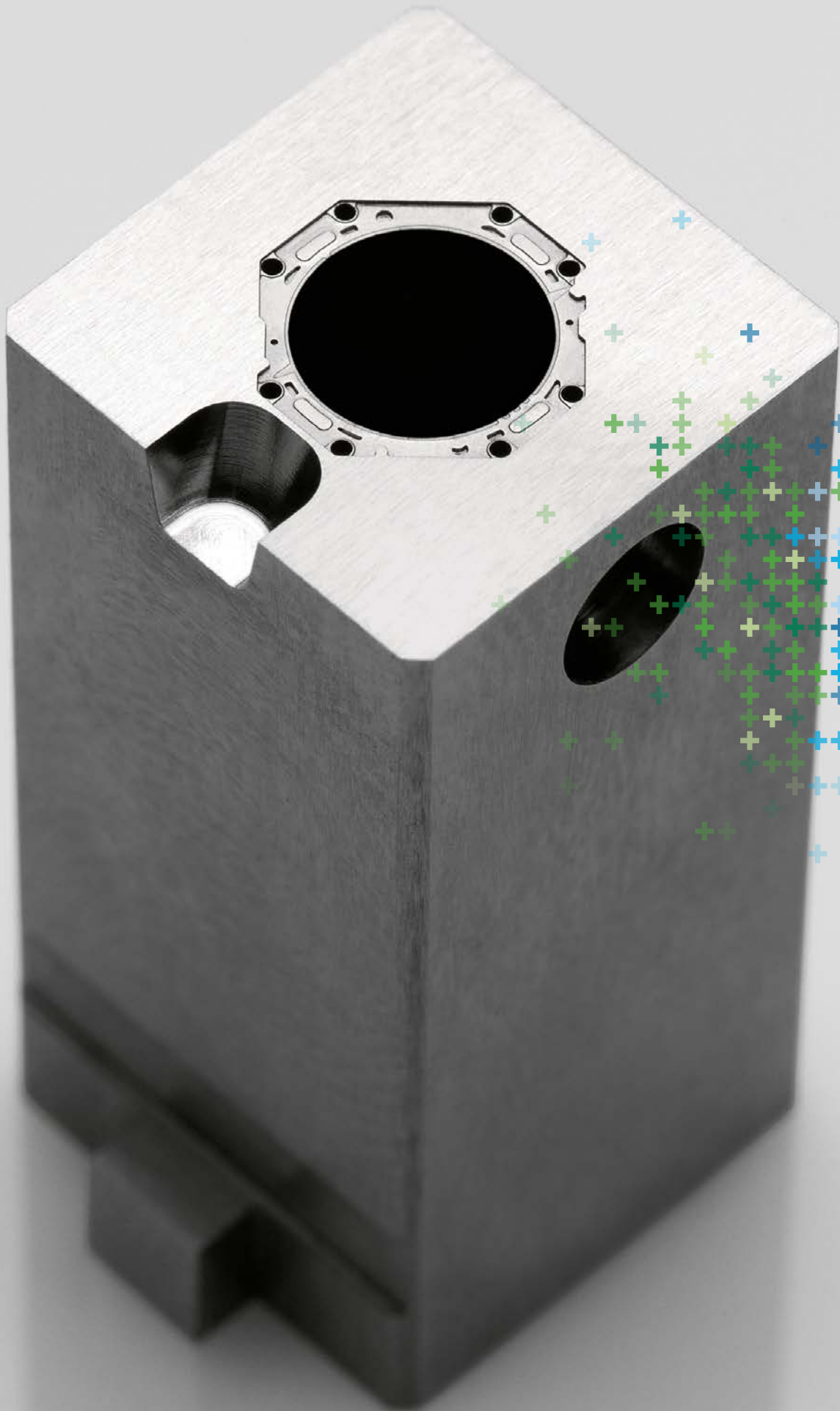

About GF Machining Solutions

Multi-technology solutions provider

Our commitment to you and your specific applications is proven by the value-adding intelligence, productivity and quality delivered by our multi-technology solutions. Your success is our chief motivator. That's why we are continuously advancing our legendary technical expertise. Wherever you are, whatever your market segment and whatever the size of your operation, we have the complete solutions and the customer-centric commitment to accelerate your success—today.

EDM (Electrical Discharge Machining)



Wire-cutting EDM

GF Machining Solutions' wire-cutting EDM is fast, precise and increasingly energy efficient. From ultraprecise machining of miniaturized components down to 0.02 mm to powerful solutions for demanding high-speed machining with respect to surface accuracy, our wire EDM solutions position you for success.

Die-sinking EDM

GF Machining Solutions is revolutionizing die-sinking EDM with features like iGAP technology to dramatically boost machining speed and reduce electrode wear. All of our die-sinking systems offer fast removal and deliver mirror finishes of Ra 0.1 µm (4 µin).

Hole-drilling EDM

GF Machining Solutions' robust hole-drilling EDM solutions enable you to drill holes in electrically conductive materials at a very high speed—and, with a five-axis configuration, at any angle on a workpiece with an inclined surface.

Tooling and Automation



Tooling

Our customers experience complete autonomy while maintaining extreme accuracy, thanks to our highly accurate System 3R reference systems for holding and positioning electrodes and work pieces. All types of machines can easily be linked, which reduces set-up times and enables a seamless transfer of workpieces between different operations.

Automation

Together with System 3R, we also provide scalable and cost-effective Automation solutions for simple, single machine cells or complex, multi-process cells, tailored to your needs.

Milling



Milling

Precision tool and mold manufacturers enjoy a competitive edge with our Mikron MILL S solutions' fast and precise machining. The Mikron MILL P machines achieve above-average productivity thanks to their high performance and Automation. Customers seeking fastest return on investment benefit from the affordable efficiency of our MILL E solutions.

High Performance Airfoil Machining

Our Liechti turnkey solutions enable the highly dynamic manufacturing of precision airfoils. Thanks to the unique performance and our expertise in airfoil machining, you increase productivity by producing at the lowest cost per part.

Spindles

As part of GF Machining Solutions, Step-Tec is engaged in the very first stage of each machining center development project. Compact design combined with excellent thermal and geometric repeatability ensure the perfect integration of this core component into the machine tool.

Software



Digitalization solutions

To drive its digital transformation, GF Machining Solutions acquired symmedia GmbH, a company specialized in software for machine connectivity. Together, we offer a complete range of Industry 4.0 solutions across all industries. The future requires the ability to adapt quickly to continual digital processes. Our intelligent manufacturing offers embedded expertise, optimized production processes, and workshop Automation: solutions for smart and connected machines.

Advanced manufacturing



Laser texturing

Aesthetic and functional texturing is easy and infinitely repeatable with our digitized Laser technology. Even complex 3D geometries, including precision parts, are textured, engraved, microstructured, marked and labeled.

Laser micromachining

GF Machining Solutions offers the industry's most complete line of Laser micromachining platforms optimized for small, high-precision features to meet the increasing need for smaller, smarter parts to support today's leading-edge products.

Laser Additive Manufacturing (AM)

GF Machining Solutions and 3D Systems, a leading global provider of additive manufacturing solutions and the pioneer of 3D printing, have partnered to introduce new metal 3D printing solutions that enable manufacturers to produce complex metal parts more efficiently.

Service + Success



We take you to new heights

Our Success Packs are designed to maximise your return on investment and empower you in your quest for success across all industrial segments. Our subscription packs feature a comprehensive range of services that guarantee the access and support you need to get the most out of your assets today, while preparing for the challenges of tomorrow. Our trusted experts backed by our latest cutting-edge, intelligent Digital Solutions, provide a full range of services.

eCatalog

Keep your equipment operating at peak precision and performance with our wide range of certified consumables and original wear parts. Our online catalog has it all (ecatalog.gfms.com).



Our locations

Switzerland

Headquarters
Biel/Bienne +++

Losone +++
Geneva ++
Langnau ++

Europe

Schorndorf, Germany ++
Coventry, United Kingdom ++
Agrate Brianza (MI), Italy ++
Barcelona, Spain ++
Marinha Grande, Portugal +
Massy, France +
La Roche Blanche, France +
Lomm, Netherlands ++
Altenmarkt, Austria ++
Warsaw, Poland ++
Brno, Czech Republic ++
Budapest, Hungary ++
Vällingby, Sweden +

America

USA
Lincolnshire (IL) ++
Chicago (IL) ++
Huntersville (NC) ++
Irvine (CA) ++

Toronto (Vaughan), Canada ++
Monterrey, Mexico ++
São Paulo, Brazil +
Caxias do Sul, Brazil +

Asia

China
Beijing +++
Changzhou ++
Shanghai ++
Chengdu ++
Dongguan ++
Hong Kong +

Yokohama, Japan ++
Taipei, Taiwan +
Taichung, Taiwan ++
Seoul, Korea ++
Singapore, Singapore ++
Petaling Jaya, Malaysia ++
Bangalore, India ++
Pune, India +
Hanoi, Vietnam ++

+ Plant ++ Center of Demonstration +++ Sales company

At a glance

We enable our customers to run their businesses efficiently and effectively by offering innovative Milling, EDM, Laser, Additive Manufacturing, Spindle, Tooling and Automation solutions. A comprehensive package of services completes our proposition.

www.gfms.com



© GF Machining Solutions Management SA, 2024
The technical data and illustrations are not binding.
They are not warranted characteristics and are
subject to change.